

DARE TO ADVENTURE

33990 CR-27  
Kiowa, Co 80117

T: 303-974-2440  
F: 303-953-5212

[www.nem-ind.com](http://www.nem-ind.com)

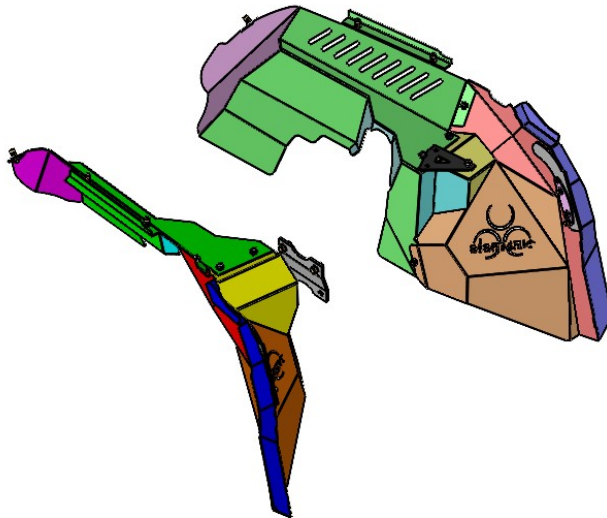

# INSTALLATION INSTRUCTIONS

Part Number

## 145710

List:	
QTY.	PART #
1	14571-91
1	14571-92
1	14571-93
1	14576-94
1	14576-17
1	14576-19
2	14580-07
1	14580-13
1	14580-14

## Box Contents:

Hardware Kit(s)

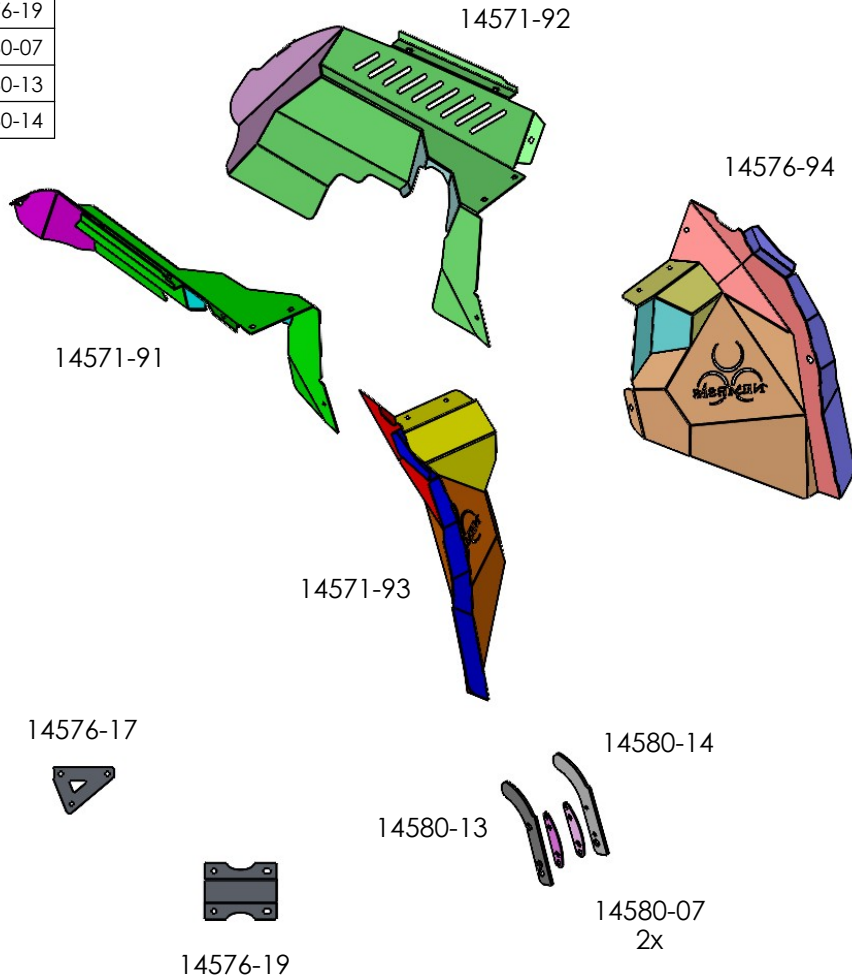

## Hardware List:

Hardware Kit May Contain Additional Hardware

Quantity	145760-01 Description - Size - Length - Part #
1	Button Head - 1/4"-20 - 5/8" - 73753
1	Flange Nut - 1/4"-20 - N/A - 37337
2	Flange Bolt - M8-1.25 - 20 - 1111624
2	Flange Nut - M8-1.25 - N/A - 90426A120

Quantity	145710-02 Description - Size - Length - Part #
8	Button Head - 1/4"-20 - 5/8" - 73753
6	Button Head - 1/4"-20 - .75" - 73754
2	Button Head - 1/4"-20 - 1" - 73755
4	Flat Head - 1/4"-20 - 5/8" - 73881
12	Flange Nut - 1/4"-20 - N/A - 37337
2	Flat Washer SAE - 1/4" - N/A - 33078
8	Flat Washer Small OD - 1/4" - N/A - 71013
8	Nutsert - 1/4"-20 - .027-.165 - 0125617

## Pre-Install Notes:

Before you start it is imperative that you read these instructions carefully. Failure to do so may result in damage to your vehicle, unsatisfactory installation, or personal injury.

1. Your personal safety is of the utmost importance. Please, exercise extreme caution when working around and under your vehicle.
2. Wear personal protective equipment such as safety glasses, hearing protection and gloves when working on your vehicle.
3. Carefully read the Product Warranty and Assumption of Risk Agreement at the end of this document if you do not consent to the terms of those agreements DO NOT proceed with the installation and contact Nemesis Industries for a RMA.
4. It is the purchasers/installers responsibility to inspect the package for any missing or damaged pieces prior to beginning installation. If any discrepancies are discovered please contact us immediately so we may rectify the situation.
5. This document is also available on our website in .pdf format with high resolution images that can be enlarged for greater clarity. Please see the product page and look under the instructions tab for this information.
6. Any reference to Drivers or Passenger sides are based on a left hand drive vehicle.
7. Do not begin the installation if you do not possess the specialty tools required to complete the install.
8. Make sure the vehicle is in park or first gear with the parking brake set. Vehicle should be on a level, sturdy surface and properly secured to prevent movement while working on it. We recommend using wheel chocks or blocks to ensure the vehicle does not move during the installation process.
9. If lifting of the vehicle is required please consult the vehicle owner's manual for proper lifting techniques and jack placement. Use jack stands to support the vehicle when working under it.
10. Use caution when lifting components into place, make sure components are secured during installation.
11. If drilling or cutting is required, eye protection is especially important to avoid injury. Also be sure to thoroughly inspect the area around where you are drilling or cutting to avoid damaging wiring or other components.
12. Use extreme caution when cutting or trimming is required.
13. Please follow the recommended specifications for torque on all hardware. We recommend checking the torque during regular routine maintenance on all aftermarket accessories.
14. Use caution when routing electrical cables and lines. Avoid moving parts, components that become hot and rough or sharp edges.
15. Always insulate and protect all exposed wiring and electrical terminals.
16. Prior to beginning the install disconnect the battery cables from both terminals and all batteries use caution to ensure that the cables do not touch.
17. When making electrical connections use dielectric grease to avoid damage from moisture and ensure a long lasting connection.
18. When installing hardware use anti-seize or similar thread lubricant to minimize the risk of damaging threads and allow for easy removal at a later time.
19. When drilling or cutting is required we recommend de-burring holes and smoothing edges. Touch up paint can be used on bare metal surfaces to help prevent rust.

## Tools:

\*\*Below is the list of tools used while performing the installation of this product. Your install may require adjusting this list to fit your vehicle specific needs.\*\*

### Sockets and Wrenches:

- 7/16" Socket
- 7/16" Wrench

### Hand Tools/Misc:

- 5/32" Hex Key/Allen Wrench
- Drill
- 9/32" Drill Bit
- Hammer
- Center Punch
- Side Cutter/Dykes
- Wire Stripper & Crimper
- Marker/Pen
- Anti-Seize
- Red Loctite

### Anti-Seize

Recommended when installing hardware into extruded nuts and nutserts

### Red Loctite -

Recommended to apply to the ribbed section of nutserts during installation

## Required Specialty Tools:

\*\*PLEASE note these tools are not readily available from local hardware stores.\*\*

(Specialty tool kit available from nem-ind.com or specialty hardware stores)

- W Drill Bit  
Used to install 1/4" nutserts
- Nutsert Installation Tool  
1/4"-20 Mandrel

## Bolt Torque Recommendations :

	Grade 5		Grade 8		Stainless Steel	
	Coarse	Fine	Coarse	Fine	Coarse	Fine
#10	-	-	-	-	22.8	31.7
1/4	6.3	7.3	9	10	6.3	7.8
5/16	13	14	18	20	11	11.8
3/8	23	26	33	37	20	22
7/16	37	41	52	58	31	33
1/2	57	64	80	90	43	45
9/16	82	91	115	129	57	63
5/8	112	128	159	180	93	104
3/4	200	223	282	315	128	124

\* Size#10 are in lb-in. \* Sizes from 1/4 up are in lb-ft.

	Grade 8.8	Grade 9.8	Grade 10.9	Grade 12.9
M5	7.0	7.8	10.0	11.7
M6	11.8	13.3	17	19.9
M8	28.8	32.3	41.3	48.3
M10	57.3	64.1	81.8	95.7
M12	99.8	112	143	167
M16	248	277	354	413

\* All Metric sizes are in lb-ft.

## Install Procedure:

**Please follow these instructions only, if you are having difficulty with a particular step or a part is not fitting as described STOP and contact us before proceeding. Taking actions outside of these instructions can result in damage to your vehicle.**

1. Starting with the left side liner first, remove factory inner liner per the factory shop manual. If you have done the left side. Complete steps 1 and 2 for the right side. Then go to Step 19.



Note: All pictures are shown with Nemesis flares. The tire is removed to have more access but installation can be completed with tire installed.

2. If your shock has an attached reservoir, you may need to remove it at this time.



3. Fir tree tabs need to be bent towards the back of the Jeep to make clearance for the liner.

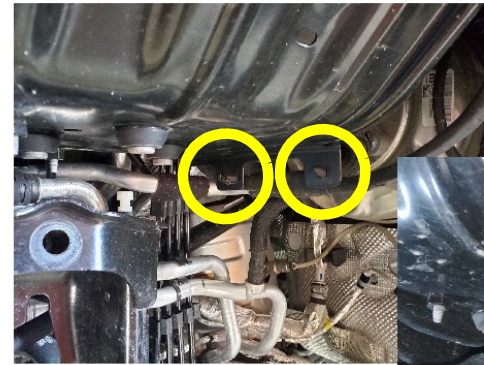

Bracket Bent



If installing on a 392. Do this step next.  
Otherwise go to step 5

4. Remove pump from factory bracket. Add new bracket to raise the pump upward and outward. Use factory hardware at the bottom. Use 2 - 5/16" x 3/4" Flange Bots with 2 - 5/16" Flange Nylock Nuts to attach the pump to the new bracket.



## Install Procedure:

Continued

5. If you have previously installed Nemesis flares, the 1 or 2 button head bolt(s) from the flare bracket will need to be removed for now. No need to remove if they are flat head bolts. (Removal depends on when your bracket was produced). If you are installing flares at the same time, follow the instructions 14580-03 or -04 bracket from flare kit instead. Refer to flare installation as needed.

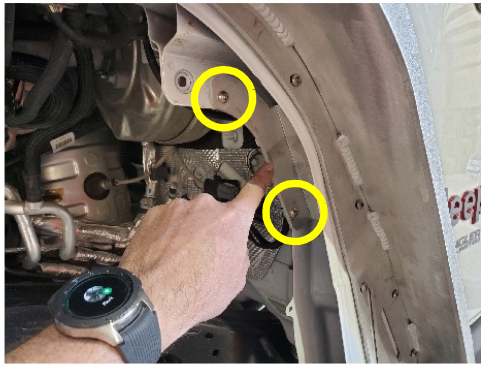

Note: Bracket maybe shaped slightly differently and have different holes from the above picture - prototype version.

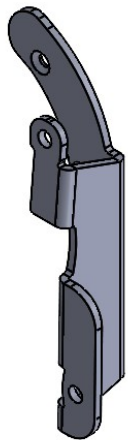

14580-03

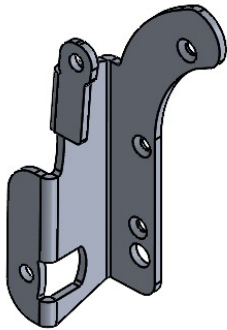

14580-04



14580-13

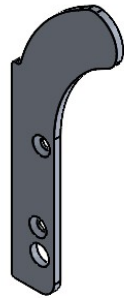

14580-14

6. Before installation check to see if there is extra body caulk on the inside fender seam. If so, remove the extra caulking.

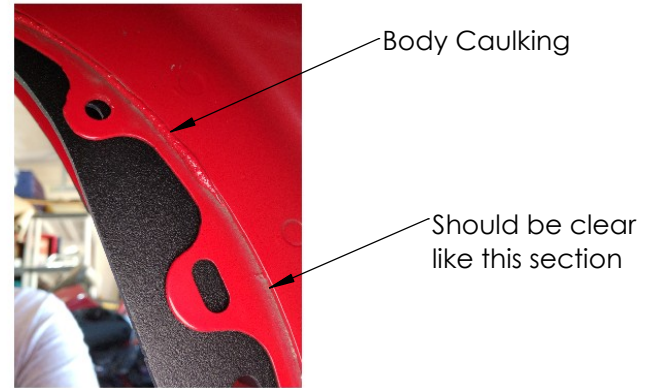

7. Install a nutsert into the 14580-07 in the hole shown, to make a left and right side.



Left

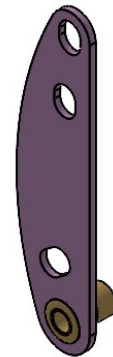

Right

## Install Procedure:

Continued

8. Install 14580-13 or -14 and 14580-07 on to the inner fender using 2 - 1/4" x 5/8" flat heads, 2 - 1/4" flange nuts and 1/4" SS flat washer(s) we supply 4 of these but you most likely not use them all. Note exploded view for the proper sequence of the items. If the flat head bolt goes through the sheet metal tab on the body it will not use a flat washer. Use a button head bolt to align the nutsert to the sheet metal tab at the bottom of the 14580-13. The key here is to align the nutsert, the sheet metal tab hole and the large hole in the 14580-13 or 14580-14. Once installed, snug the 2 flat head bolts. Remove the bolt you used for alignment.

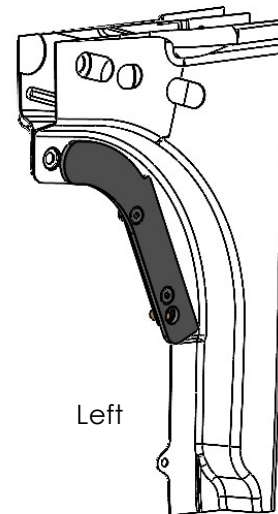
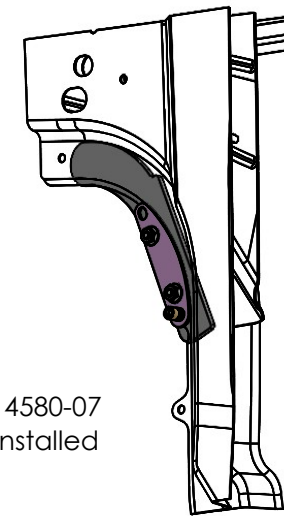
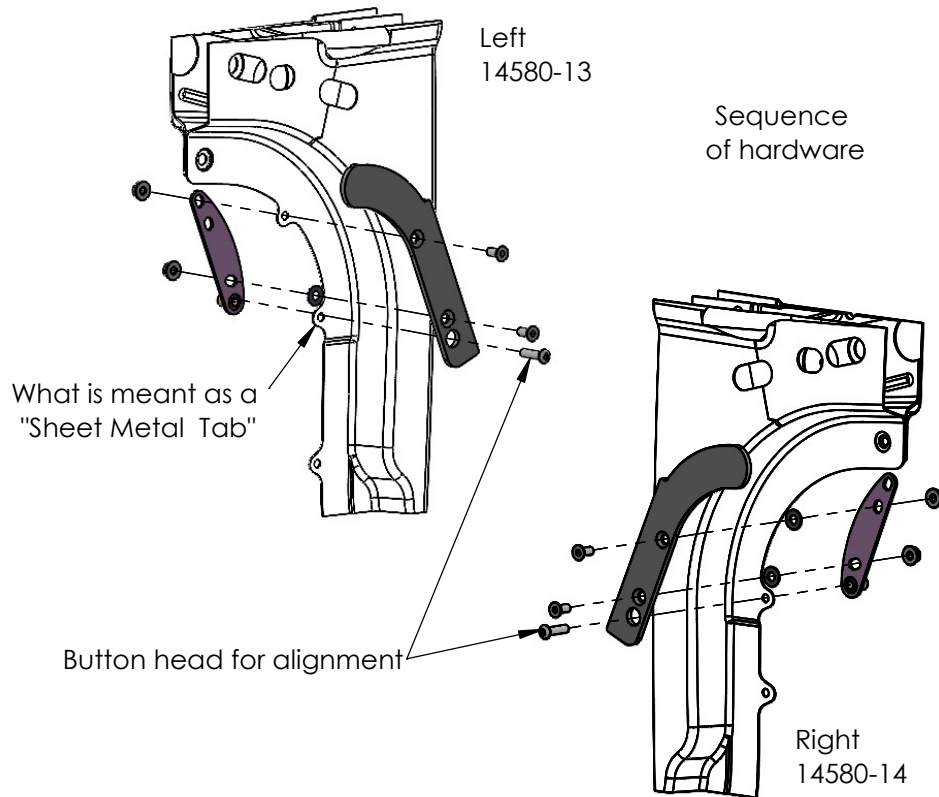

Installed

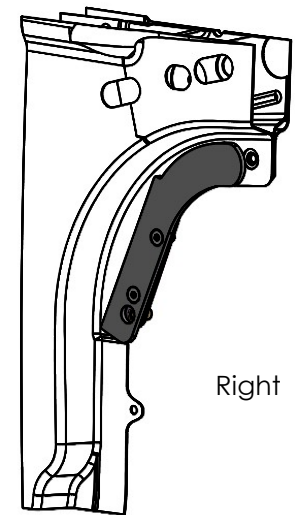

## Install Procedure:

Continued

9. Assemble front and back inner liners as shown below.

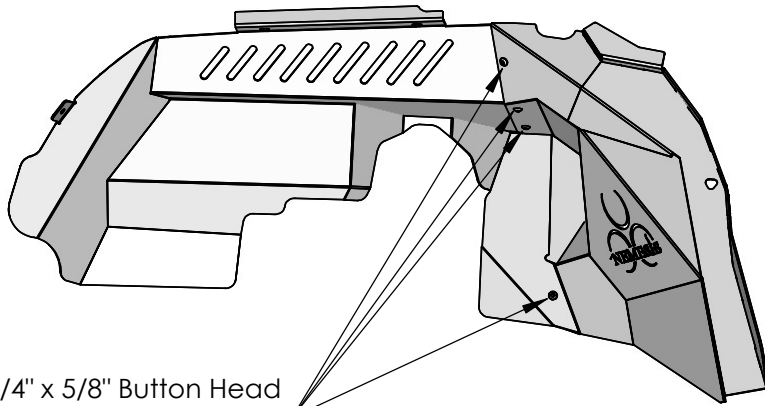

4 - 1/4" x 5/8" Button Head Bolts and 1/4" Flange Nuts

10. Install the assembled liner, start with the back of the liner first, then the front in last.

11. Push the liner assembly up to the main fender support, then push it towards the front of the same support. However the top of the liner should be close to centered on the factory flare supports. Shown in the next two pictures. The top of the liner should fit to the bottom and side of the top support. The front tab should sit as shown below.



12. Mark the 2 top holes while pushing the liner assembly up and into the body beam. Mark the front hole while holding the liner as shown in step 11.



Factory Flare Supports

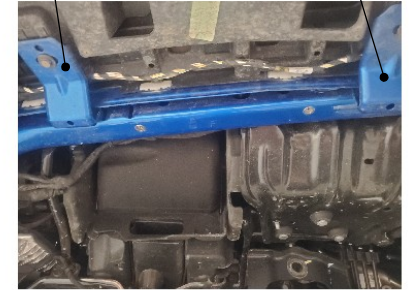

13. Remove liner and drill the marked holes with a "W" drill bit. Deburr holes.

14. Install 3 - 1/4" - .027-.165 nutserts into the holes.

15. Install liner with 3 - 1/4" x 3/4" button head bolts where the above nutserts are installed. Install 1 - 1/4" x 1" button head bolt in the location circled below.

(If you are on the right side liner, you are now complete)



Old version pictured

## Install Procedure:

Continued

16. If you had to remove the shock, reinstall the left side shock at this time. The left side is complete at this point.

17. Installation of the **right side** has a few extra steps. To start, complete Step 1 and 2, then come back here and continue with Step 18.

18. After completing Steps 1 and 2 on the right side, cut this bolt off leaving about 1/4" of threads. See picture below.

After

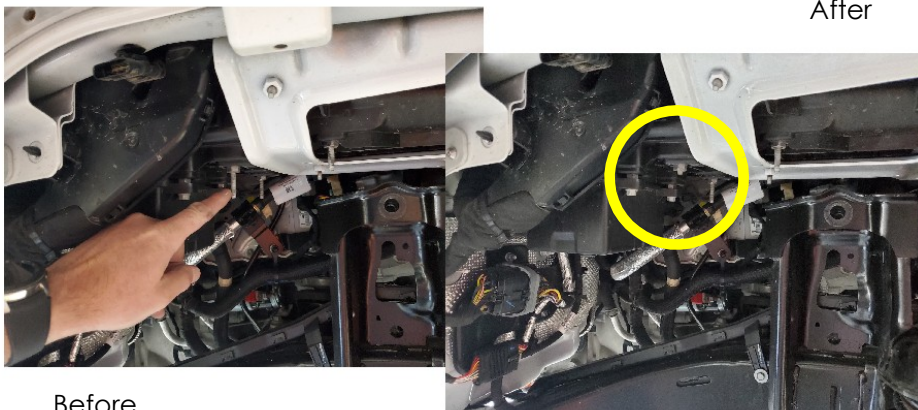

Before

19. Cut the 2 bolts, pictured below, so they just stick out of the nuts.

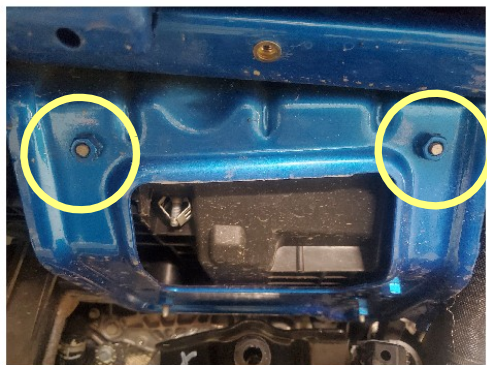

20. Cut fir tree off to be close to the outer sheet metal but not so close it will fall out of its hole. Fir tree should not extend more than 3/16" past the sheet metal.



21. If you have this plug, remove the plug from the fir tree and move it towards the center of the Jeep. The outside edge should not stick out past shock mount. Use zip ties as needed.



If you are installing the liners in a 392 jeep, do steps 22 & 23.  
Otherwise go to step 24.

## Install Procedure:

Continued

22. Remove battery to access these 2 bolts.



23. Add 14575-01 to the vacuum bottle using 1 - 1/4" x 5/8" button head and 1/4" flange nut. Transfer clip from bottle mount to 14575-01. As shown below. Then reinstall bottle.

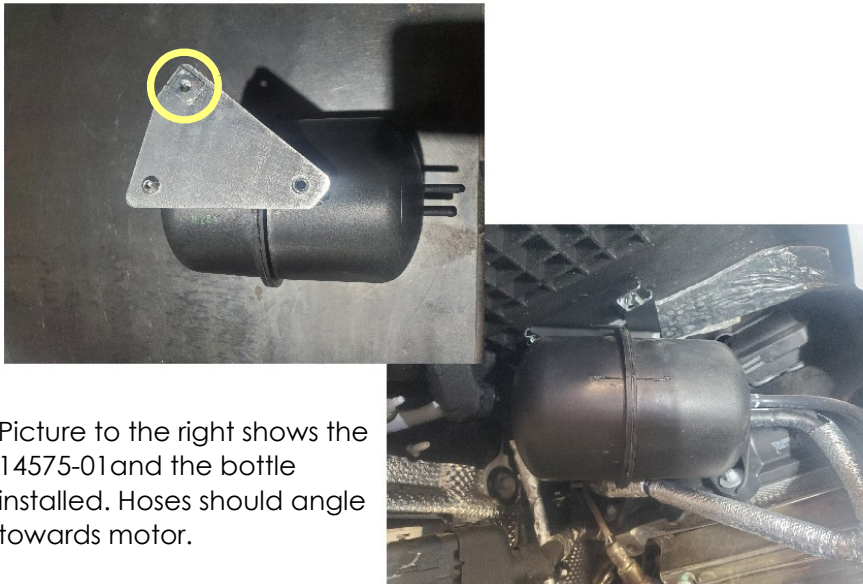

Picture to the right shows the 14575-01 and the bottle installed. Hoses should angle towards motor.

24. Follow steps 5 to 15 to complete the right side installation.

## Nutsert Issues:

### 1. Nutsert alignment:

If a nutsert is installed slightly out of alignment with a mating hole, follow the below steps to avoid ruining the nutsert.

**a.** Bolt the part to the vehicle using all of the holes that are properly aligned.

**b.** Use the matching size and thread pitch tap and gently thread it into the nutsert. The tapered end of the tap must be able to align to the nutsert for this to work.

**c.** Gently run the tap through the nutsert and allow it to cut away some of the aluminum from the part.

**d.** Remove the tap and clean out any debris left over on the inside of the nutsert.

**e.** Reinstall the bolt into the nutsert.

### 2. Removing a damaged nutsert:

Nutserts can be drilled out if they are damaged during the install process, you can follow the below steps to remove a damaged nutsert.

**a.** Remove the part from the vehicle.

**b.** Using the same size drill bit as used for the installation carefully drill into the nutsert. This will cut away the front lip that holds the nut insert to the body. Be careful not to enlarge the hole since you will need to install a new nutsert into the existing location.

**NOTE.** The nutsert will drop into the body cavity of the Jeep and most likely will not be able to be removed.

## Warranty:

Our goal at Nemesis Industries, Inc.™ is to ensure you are delighted not only with this purchase, but also with any additional purchases and to that end Nemesis offers a five (5) day from delivery date no questions asked return policy if products are returned in an "unused" condition. However, this return policy excludes custom parts or parts with powder coat. In addition, Nemesis warrants your product for one (1) year from the date of sale to be free from defects in material and workmanship under normal installation and use. This warranty is limited to the costs of repair and replacement of the Nemesis Industries product only. Therefore, no type of labor or shipping allowance is available in connection with a customer's repair, removal, reinstallation or return of a damaged product. Should any questions arise, please contact Nemesis at (303) 974-2440 or info@nem-ind.com. We remind you that all finishes, painted or powder coated, must be cleaned and waxed regularly and the portion of the warranty concerning the product's finish does not apply to products that have been chipped, scratched or damaged in any way. All warranty claims are subject to inspection by Nemesis. Following such inspection, the product in question may either be repaired or replaced when found defective. Prior to any replacement or repair, written authorization as to the action to be taken shall be issued by Nemesis. Failure to contact Nemesis prior to having warranty work performed shall immediately void all applicable warranties.

**THE WARRANTY EXPRESSED ABOVE IS THE SOLE WARRANTY OF NEMESIS INDUSTRIES AND ANY OTHER EXPRESSED OR IMPLIED WARRANTIES ARE HEREBY SPECIFICALLY EXCLUDED AND DISCLAIMED, INCLUDING, BUT NOT LIMITED TO, THE IMPLIED WARRANTIES OF MERCHANTABILITY AND FITNESS FOR A PARTICULAR PURPOSE. EXCEPT FOR THE LIMITED WARRANTY DESCRIBED HEREIN, NEMESIS INDUSTRIES SHALL NOT BE LIABLE TO ANYONE FOR INCIDENTAL, CONSEQUENTIAL, PUNITIVE, SPECIAL OR EXEMPLARY DAMAGES OR OTHER DIRECT OR INDIRECT DAMAGES OF ANY TYPE OR KIND ARISING FROM ANY BREACH OF WARRANTY ARISING FROM OR IN CONNECTION WITH THE PURCHASE OF NEMESIS INDUSTRIES PRODUCTS.**

## Assumption of Risk, Indemnity and Release:

**Customer's Acknowledgments.** Customer understands and acknowledges that products purchased from Nemesis Industries, Inc. ("Nemesis") are designed to protect against certain types of property damage from minor impacts, but are not designed as a crash safety device, or as an impact resistant product designed for the protection of occupants, but instead are cosmetic enhancements to assist in protecting against minor impact damage with certain stationary obstacles. As a result, Customer also understands and acknowledges that the installation of Nemesis products on a Vehicle and the voluntary use of that Vehicle for off-road activities (each, hereinafter, and an "Off-Road Activity") is inherently dangerous and hazardous and can result in damage to the Vehicle, to others, to the property of others and in the serious event, bodily injury or death to Customer or others.

**Use in an Off-Road Activity.** By accepting a Nemesis product and using such product in any Off-Road Activity, Customer accepts and agrees to all of the terms described below (the "Release"); provided that Customer may in lieu of accepting the terms of this Release and prior to installation, elect to return any Nemesis product and receive a full refund. Such return may be initiated by contacting a Nemesis sales representative or by directly contacting Nemesis at (303) 974-2440 or at info@nem-ind.com for the issuance of a RMA for the product in question. Once the product being returned has been received by Nemesis in good condition, a full refund will be issued minus shipping charges.

**Assumption of Risk and Release.** Customer assumes all risk and responsibility of engaging in an Off-Road Activity which is acknowledged as being inherently dangerous. Customer understands that persons participating in an Off-Road Activity must possess specialized knowledge and skills, and in voluntarily deciding to do so, Customer assumes all risks inherent therein which may be encountered at any time in connection with an Off-Road Activity. With full knowledge of the above and all risks inherent therein, Customer and others who may voluntarily choose to engage in an Off-Road Activity accept full responsibility for and assume all risks associated with engaging in an Off-Road Activity, whether known, unknown, or inherent, and acknowledge and agree that such persons are assuming all responsibility for any and all consequences resulting from the participation in an Off-Road Activity, including, but not limited to, injury and/or death to Customer or others and damage to the Vehicle and other property. Customer and each other participant in any Off-Road Activity hereby release, and forever discharge and shall hold harmless each other and Nemesis, including all of their respective predecessors, affiliates, successors, assigns, partners, venturers, principals, officers, directors, managers, shareholders, attorneys and agents and their respective insurance carriers (the "Released Parties") and hereby release and forever discharge, indemnify and hold harmless the Released Parties, and any and all persons claiming under them, however involved, of and from any and all liability for any and all claims, demands, damages and costs, liabilities, losses, expenses, obligations, compensations, reimbursements, actions, rights, loss of profits, and rights and causes of action, of every kind and nature whatsoever, including court costs and attorney fees, whether known or unknown, which Customer and any other participant may now have, or claim at any future time to have, arising from or growing out of, or by reason of, or based in whole or in part upon, any act, omission, event, transaction, matter or thing involved, alleged or referred to, whether direct or indirect, involving an Off-Road Activity.

**Release of Unknown Claims.** Customer and any other participant fully realize that in participating in an Off-Road Activity they may sustain unknown and unforeseen losses, costs, expenses, damages, liabilities, and claims, and the consequences thereof, which may be at this time, and hereafter unknown, unrecognized and not contemplated by them. By participating in an Off-Road Activity, Customer and any other participant intend to release the Released Parties from any and all liability for any and all such unknown and unforeseen losses, expenses, damages, costs, liabilities, and the consequences thereof, not known, recognized nor contemplated at any time by them, which result or may result from an Off-Road Activity. Customer and any other participant expressly and forever waive any right to assert that this Release was the result of a mistake of any kind, waiving all claims based upon the doctrine of mistake.

**Covenant Not to Sue.** Customer and any other participant specifically covenant and agree, each with the other, never to institute or participate in any suit or action, including class actions, at law or in equity, whether sounding in tort or contract, against the Released Parties and all persons claiming under them or any of them by reason of any claim, demand, action, or cause of action described in this Release.

**Miscellaneous Provisions.** This Release shall be binding in all respects upon, and shall inure to the benefit of the Released Parties and their heirs, successors and assigns. This Release shall be governed by the laws of the State of Colorado, and the sole and exclusive jurisdiction for the determination of any controversy or claim arising out of the purchase of any Nemesis product shall be in the District Court of Elbert County, Colorado. In the event that a court of competent jurisdiction enters judgment declaring any material provision of this Release invalid or unenforceable, the remainder of this Release shall remain in full force and effect and such provision shall be limited or eliminated to the minimum extent necessary so that such invalid or unenforceable provision shall otherwise remain in force or effect. Neither Customer nor any other participant shall be entitled to any favorable construction of any provision of this Release because the Release was drafted by Nemesis or by an attorney for Nemesis. The acceptance of a Nemesis product constitutes Customer's voluntary acceptance of this Release, Customer's acknowledgement that no oral statements or inducements have been made and that full and adequate consideration has been received for this Release.